

Model(型號): H06F21



Features:

Compact design with a good space factor

特點:

結構緊湊，有不同裝配方式

Dimensions(規格圖):

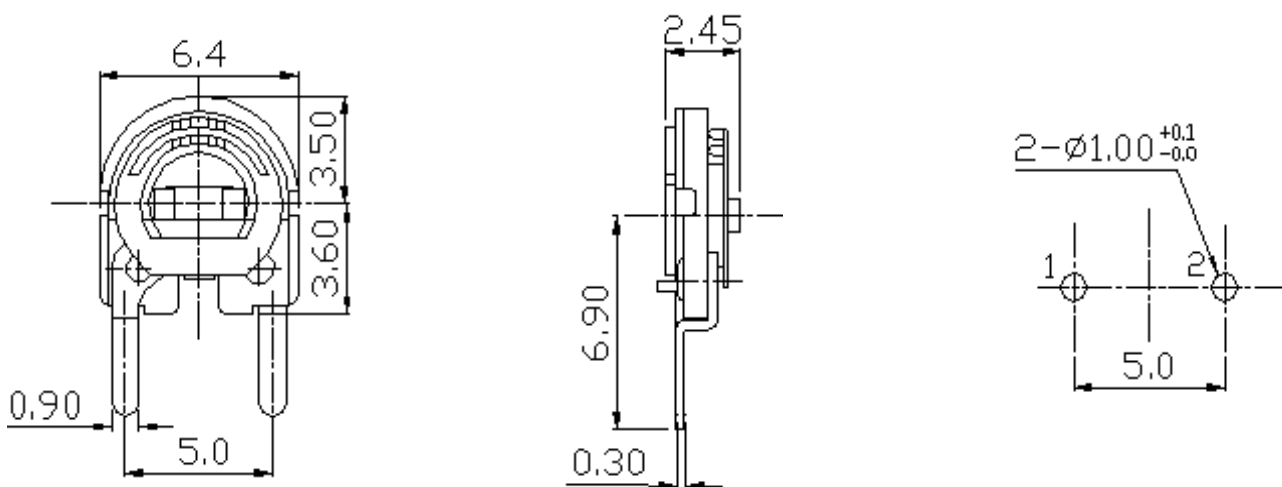

Specifications(規格)

Electrical Characteristics [電氣性能]

Total resistance [全阻抗值]	100 Ω - 1M Ω
Total resistance tolerance [全阻抗值容許差]	±20%
Ratings power(w) [額定功率]	0.10W
Resistance taper [阻抗變化特性]	B
Max. operating voltage [最高使用電壓]	50V

Mechanical Characteristics [機械性能]

Operation torque [回轉力矩]	80gf.cm to 120gf.cm
Rotation stopper strength [止動強度]	0.5Kgf.cm Max
Total rotational angle [回轉角度]	220° ±20°

Endurance Characteristics [耐久性能]

Rotational life [回轉壽命]	More than 100 cycles
--------------------------	----------------------